

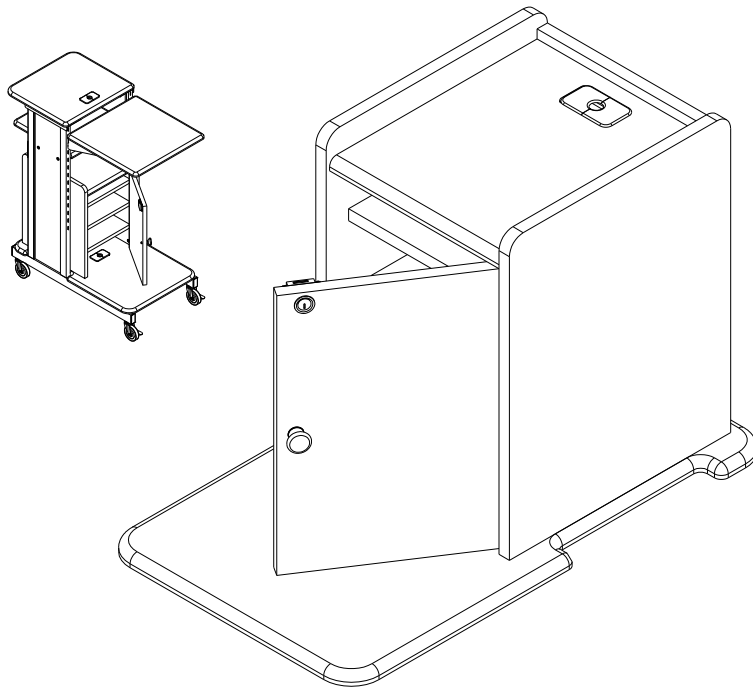











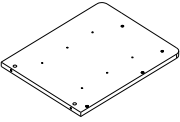





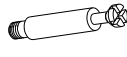

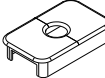
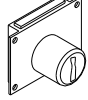

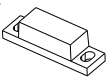





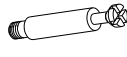

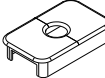
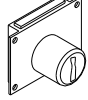

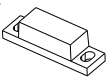

# Security Cabinet

for Presentation Cart

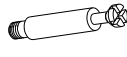

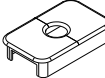
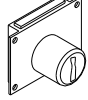
## Assembly Instructions

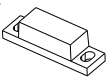
# Security Cabinet

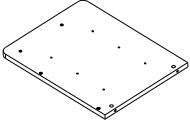
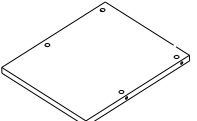
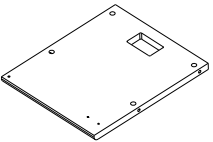
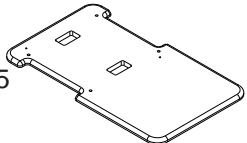
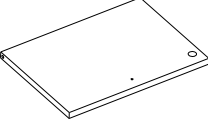
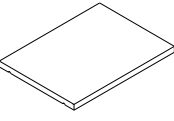
Part	Drawing	Description	Qty	Part	Drawing	Description	Qty																																																				
P-1		Left Side Panel	1 EA	<div style="text-align: center; font-weight: bold; margin-bottom: 10px;">Hardware List</div> <table border="0"> <tr> <td>A</td> <td></td> <td>Short Wood Screw</td> <td>4 EA</td> </tr> <tr> <td>A1</td> <td></td> <td>Phillips Head Screw (Door Knob)</td> <td>1 EA</td> </tr> <tr> <td>A2</td> <td></td> <td>Long Wood Screw</td> <td>2 EA</td> </tr> <tr> <td>B</td> <td></td> <td>Metal Support Pins</td> <td>12 EA</td> </tr> <tr> <td>C</td> <td></td> <td>Cam Lock</td> <td>12 EA</td> </tr> <tr> <td>D</td> <td></td> <td>Cam Post</td> <td>12 EA</td> </tr> <tr> <td>E</td> <td></td> <td>Spring Button</td> <td>2 EA</td> </tr> <tr> <td>F</td> <td></td> <td>Plastic Grommet</td> <td>3 EA</td> </tr> <tr> <td>G</td> <td></td> <td>Door Lock w/Lock ring</td> <td>1 EA</td> </tr> <tr> <td>H</td> <td></td> <td>Key</td> <td>2 EA</td> </tr> <tr> <td>J</td> <td></td> <td>Door Knob</td> <td>1 EA</td> </tr> <tr> <td>K</td> <td></td> <td>Door Magnet</td> <td>1 EA</td> </tr> <tr> <td>L</td> <td></td> <td>Allen Wrench</td> <td>1 EA</td> </tr> </table>				A		Short Wood Screw	4 EA	A1		Phillips Head Screw (Door Knob)	1 EA	A2		Long Wood Screw	2 EA	B		Metal Support Pins	12 EA	C		Cam Lock	12 EA	D		Cam Post	12 EA	E		Spring Button	2 EA	F		Plastic Grommet	3 EA	G		Door Lock w/Lock ring	1 EA	H		Key	2 EA	J		Door Knob	1 EA	K		Door Magnet	1 EA	L		Allen Wrench	1 EA
A		Short Wood Screw	4 EA																																																								
A1		Phillips Head Screw (Door Knob)	1 EA																																																								
A2		Long Wood Screw	2 EA																																																								
B		Metal Support Pins	12 EA																																																								
C		Cam Lock	12 EA																																																								
D		Cam Post	12 EA																																																								
E		Spring Button	2 EA																																																								
F		Plastic Grommet	3 EA																																																								
G		Door Lock w/Lock ring	1 EA																																																								
H		Key	2 EA																																																								
J		Door Knob	1 EA																																																								
K		Door Magnet	1 EA																																																								
L		Allen Wrench	1 EA																																																								
P-2		Right Side Panel	1 EA																																																								
P-3		Back Panel	1 EA																																																								
P-4		Top Platform	1 EA																																																								
P-5		Bottom Platform	1 EA																																																								
P-6		Door	1 EA																																																								
P-7		Removeable Shelf	3 EA																																																								

Do not use unless all screws are tight. At least every six months, check all screws to be sure they are tight. If parts are missing, broken, damaged, or worn, stop use of the product until repairs are made by your dealer using factory authorized parts.

**Should you require assistance during assembly,  
please call our Customer Service Department**  
**Monday - Friday 8 a.m. - 5 p.m.**  
**Central Standard Time**  
**Toll-Free Customer Service**  
**1-800-749-2258**

# Security Cabinet

## Assembly Diagram

To Assemble:

1. Identify and Separate all the Parts and Hardware.
2. Place the Left Side Panel (P-1) with the Predrilled holes facing up and install 4 each Cam Posts (D) in the 4 pre-drilled holes as shown in illustration # 1.
3. Install 2 each Cam Locks (C) into the large holes as shown in illustration # 1.
4. Repeat Steps 2 & 3 for the Right Side Panel (P-2).
5. Place the Back Panel (P-3) with the Holes facing up and install 4 each Cam Locks (C) into the large holes as shown in illustration # 2.

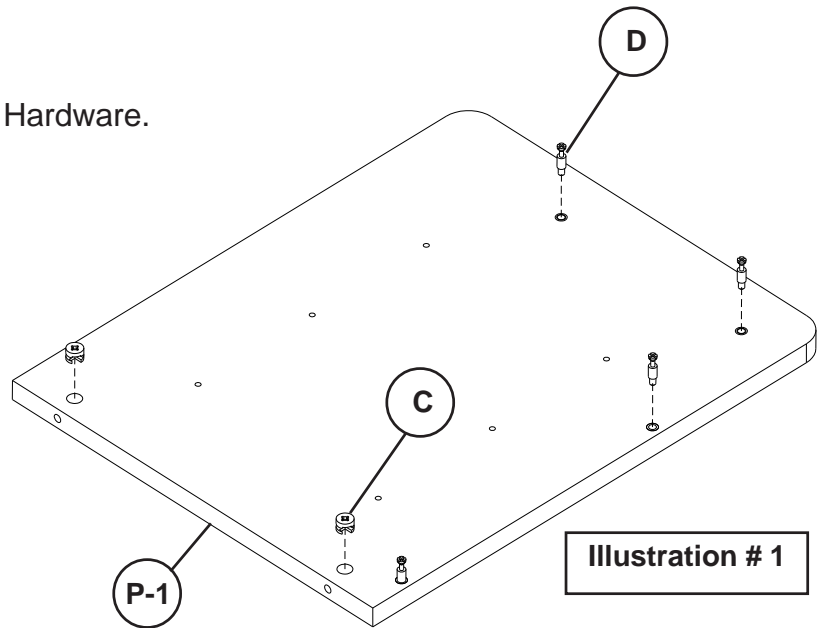

Illustration # 1

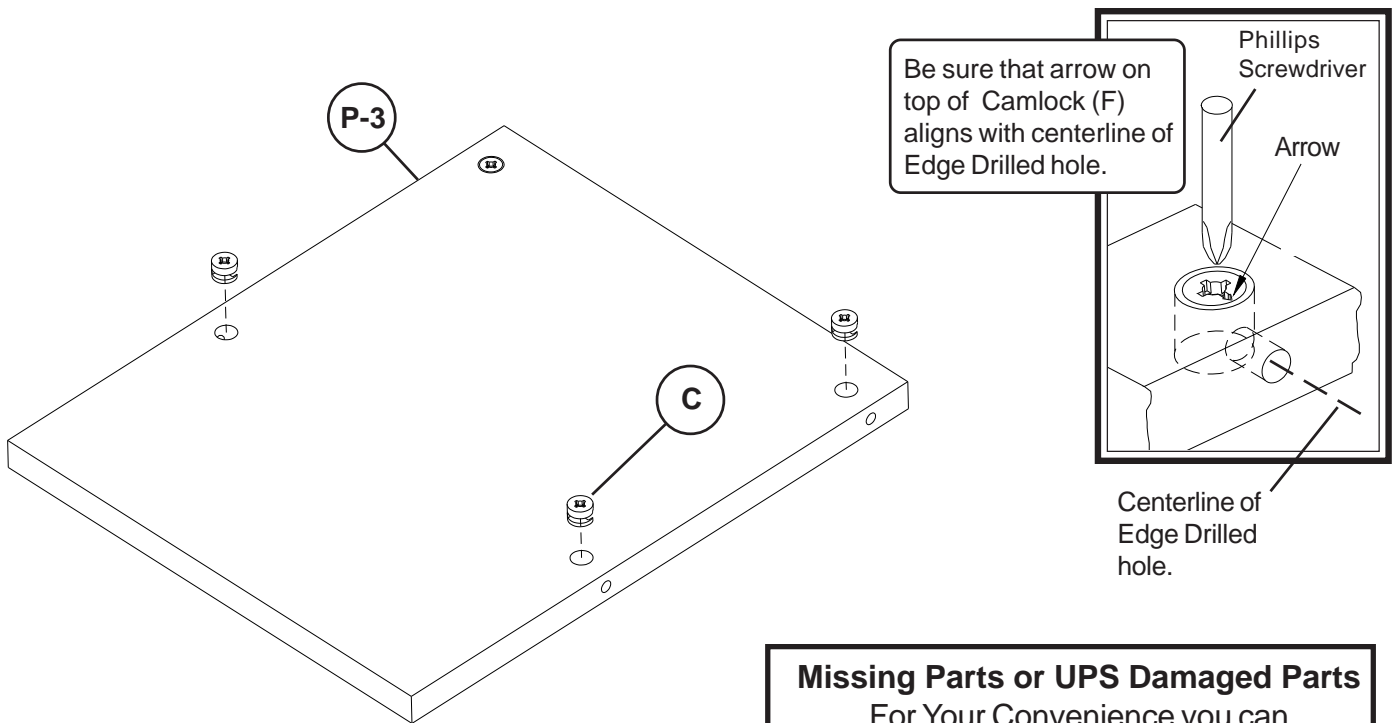

Illustration # 2

**Missing Parts or UPS Damaged Parts**  
 For Your Convenience you can  
 EMAIL us at  
***support@moorecoinc.com***  
 24HOURS 7 DAYS A WEEK

6. Place the Door (P-6) with the Screw Holes facing up and install 1 Lock (G) into the large hole using 4 Wood Screws (A). Press Lock Ring on from front side as shown in illustration # 3.

7. Attach Door Knob (J) to Door (P-6) using 1 each (A1) screw.

8. Locate 2 each Spring Buttons (E) in the top and bottom of door (P-6).

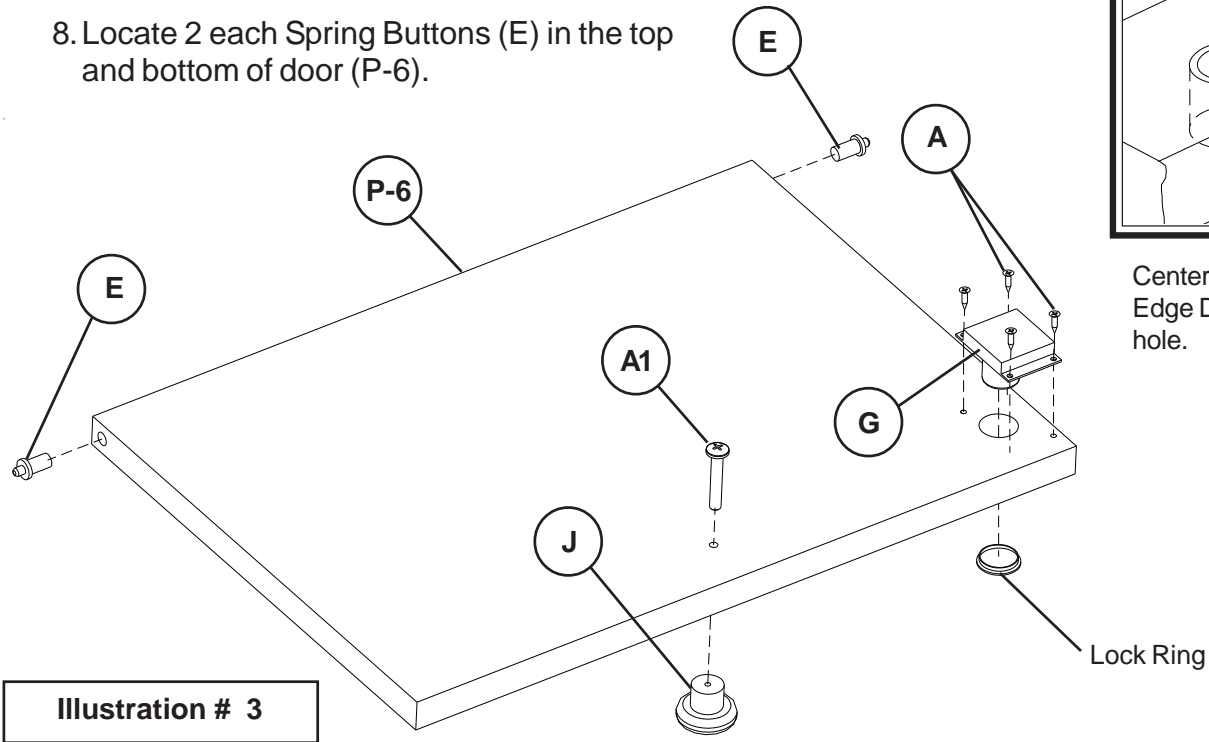
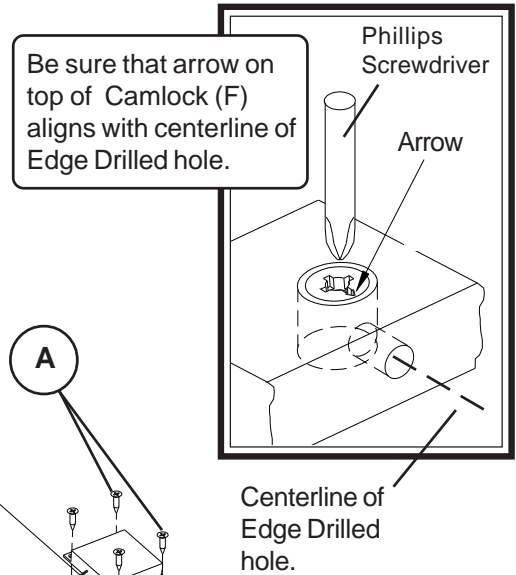

**Illustration # 3**

9. Place the Top Panel (P-4) with the Holes facing up and install 4 each Cam Locks (C) into the large holes as shown in illustration # 4.

10. Attach 1 each Door Magnet (K) to the Top Panel (P-4) and secure using 2 Wood Screws (A2) as shown in illustration # 4.

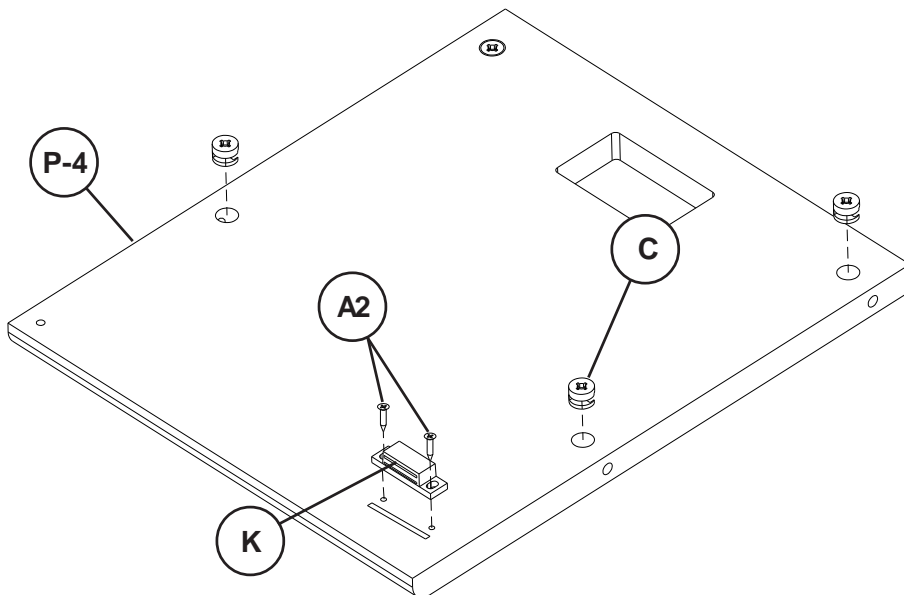
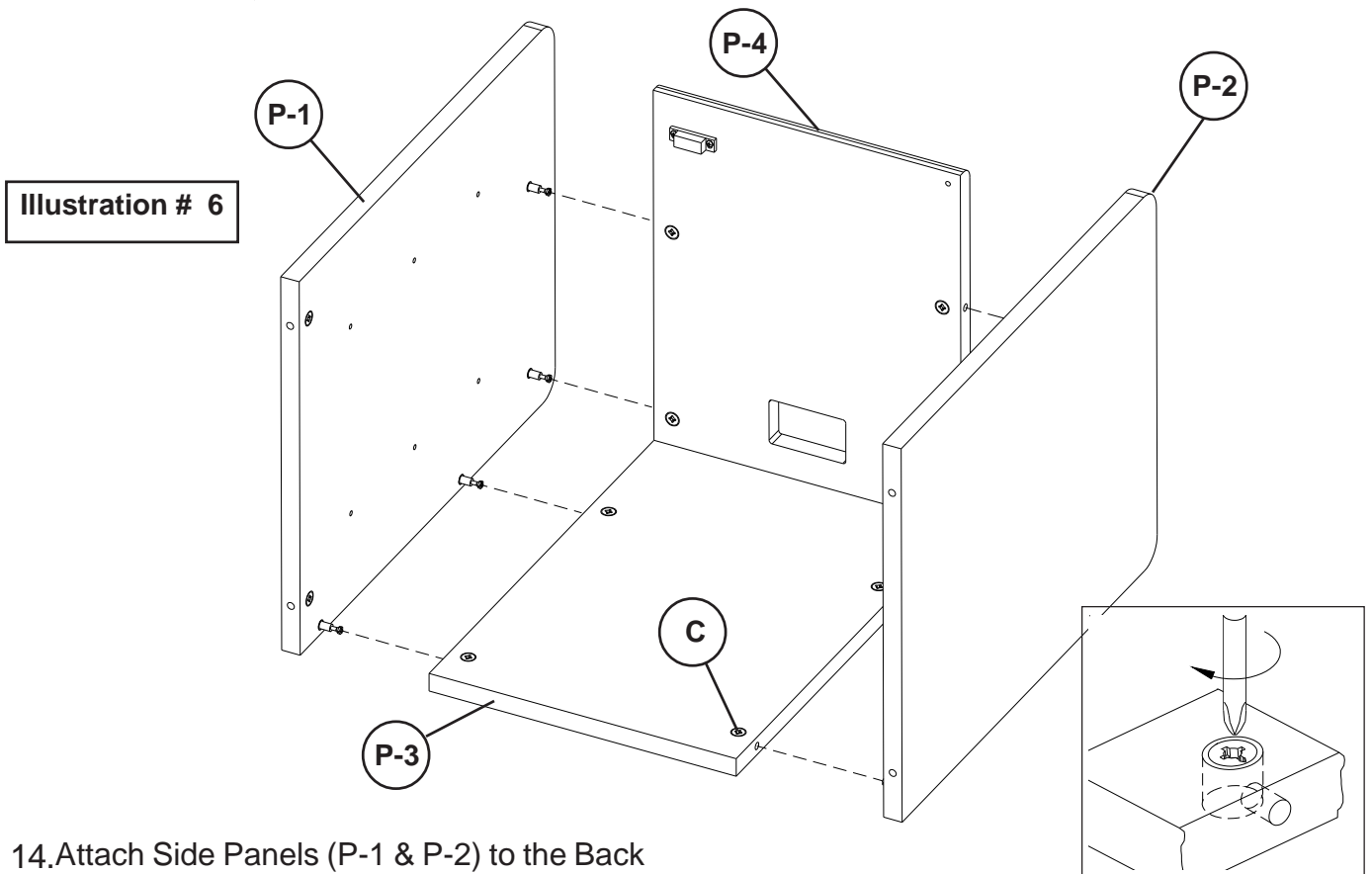
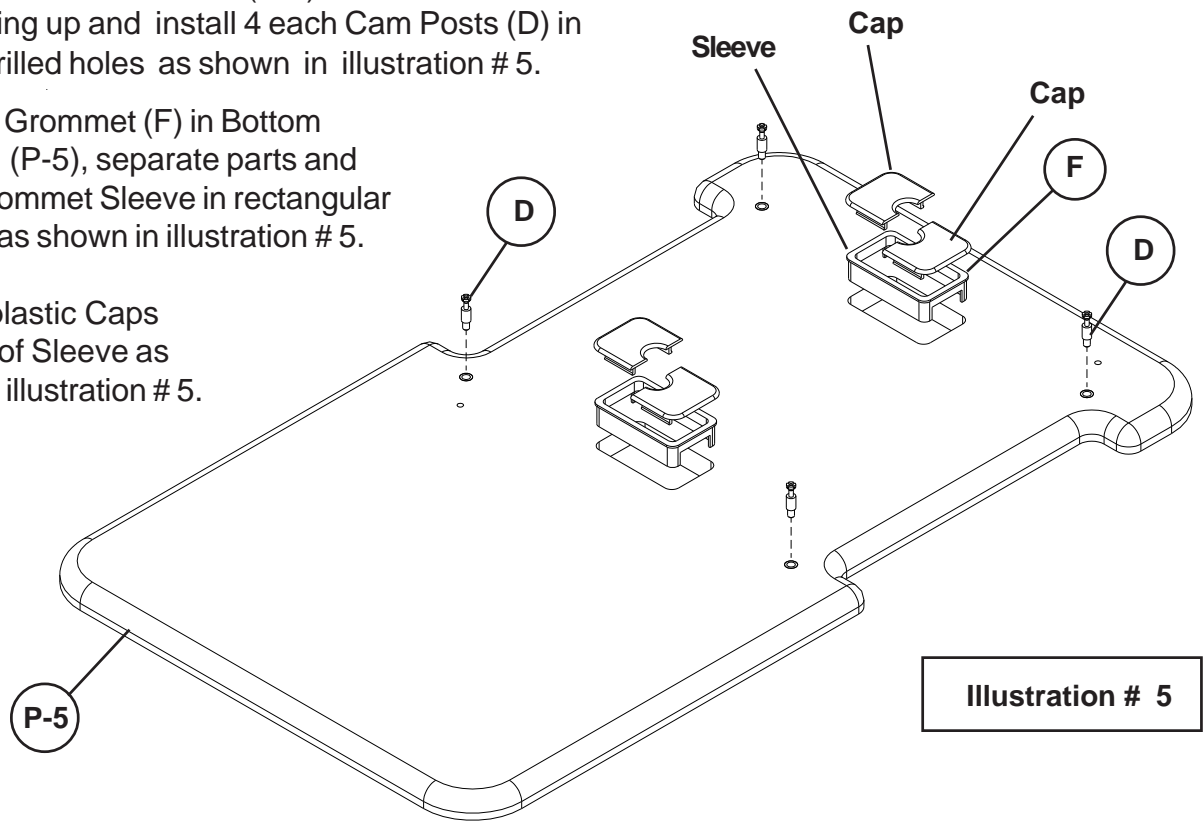

**Illustration # 4**

11. Place the Bottom Platform (P-5) with the Predrilled holes facing up and install 4 each Cam Posts (D) in the pre-drilled holes as shown in illustration # 5.

12. To install Grommet (F) in Bottom Platform (P-5), separate parts and press Grommet Sleeve in rectangular opening as shown in illustration # 5.

13. Snap 2 plastic Caps over top of Sleeve as shown in illustration # 5.



14. Attach Side Panels (P-1 & P-2) to the Back Panel (P-3) and the Top Panel (P-4) as shown in illustration # 6. Secure by turning the Cam Locks (C) 1/4" Turn until they lock.

To Secure Cam Locks, Insert Large Phillips Head Screwdriver and turn Cam Lock 1/4 turn (90 degrees) clockwise.

15. Remove bottom Shelf from Presentation Cart using Allen Wrench (L).

16. Remove the Metal Stability Panel from Presentation Cart using Allen Wrench (L).

17. Attach Bottom Platform (P-5) w/cam posts to the Right & Left Leg Assemblies of Presentation Cart using 6 each screws as shown in illustration # 7.

18. Tighten Screws using Allen Wrench (L).

6 Screws from Presentation Cart

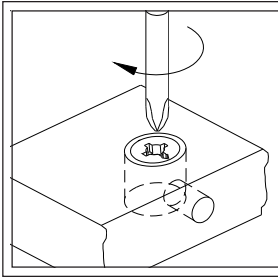
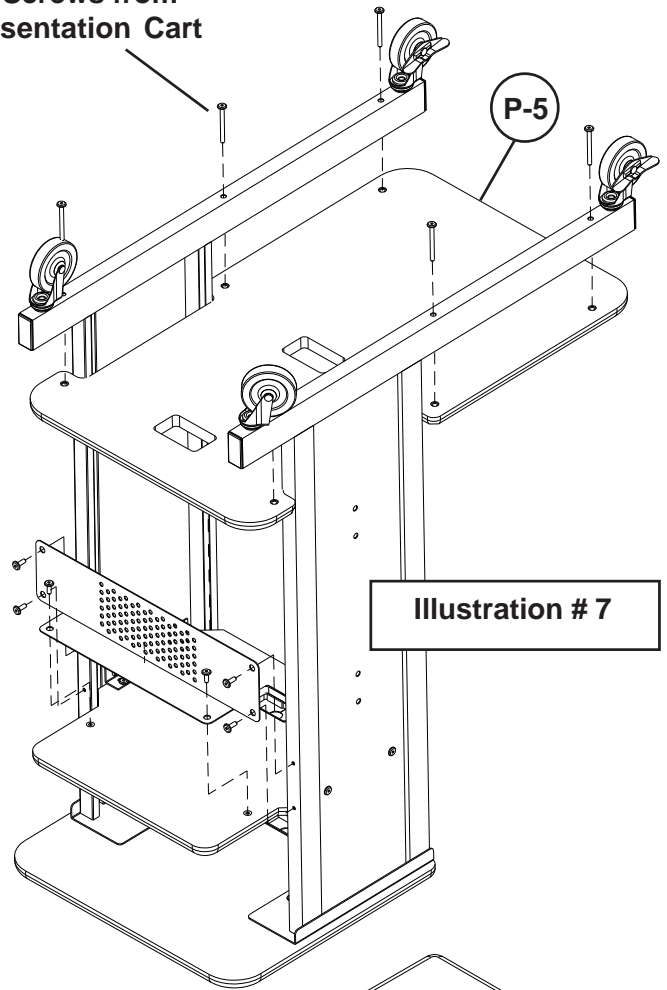

To Secure Cam Locks, Insert Large Phillips Head Screwdriver and turn Cam Lock 1/4 turn (90 degrees) clockwise.

19. To install Grommets (F) in Top Platform (P-4), separate parts and press Grommet Sleeve in rectangular opening as shown in illustration # 8.

20. Snap 2 plastic Caps over top of Sleeve as shown in illustration # 8.

Cabinet can be installed facing the front or back of unit.

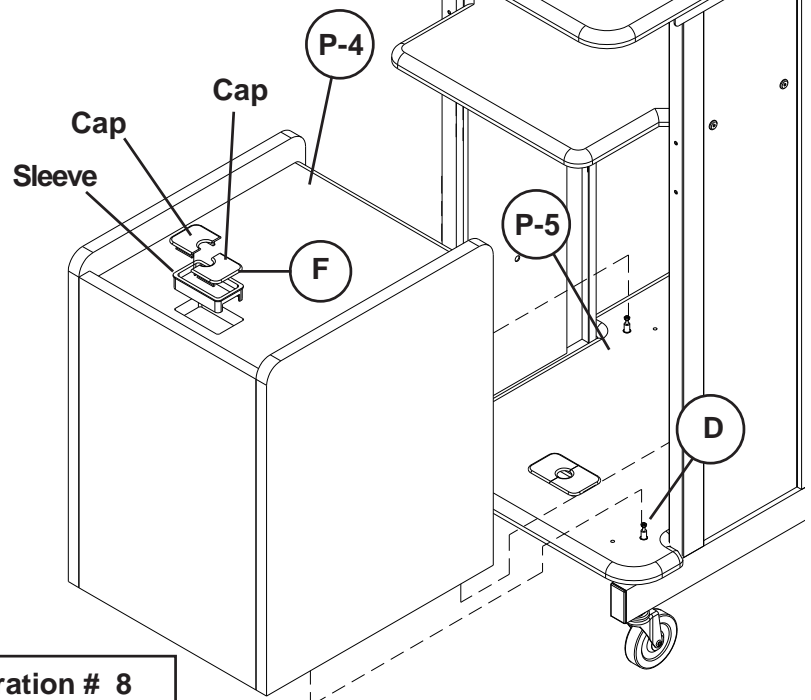
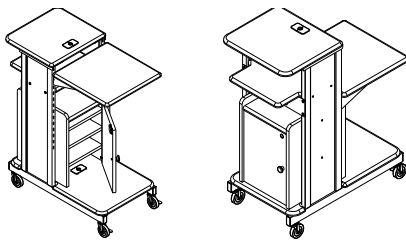

21. Secure Cabinet assembly to Bottom Platform (P-5) by turning the Cam Locks (C) 1/4 Turn until they lock.

Illustration # 8

Illustration # 9

22. Place 12 Shelf Support Pins (B) in each of the two Side Panels (P-1 & P-2). Place Removable Shelves (P-7) on 12 Shelf Support Pins as shown in illustration #9.

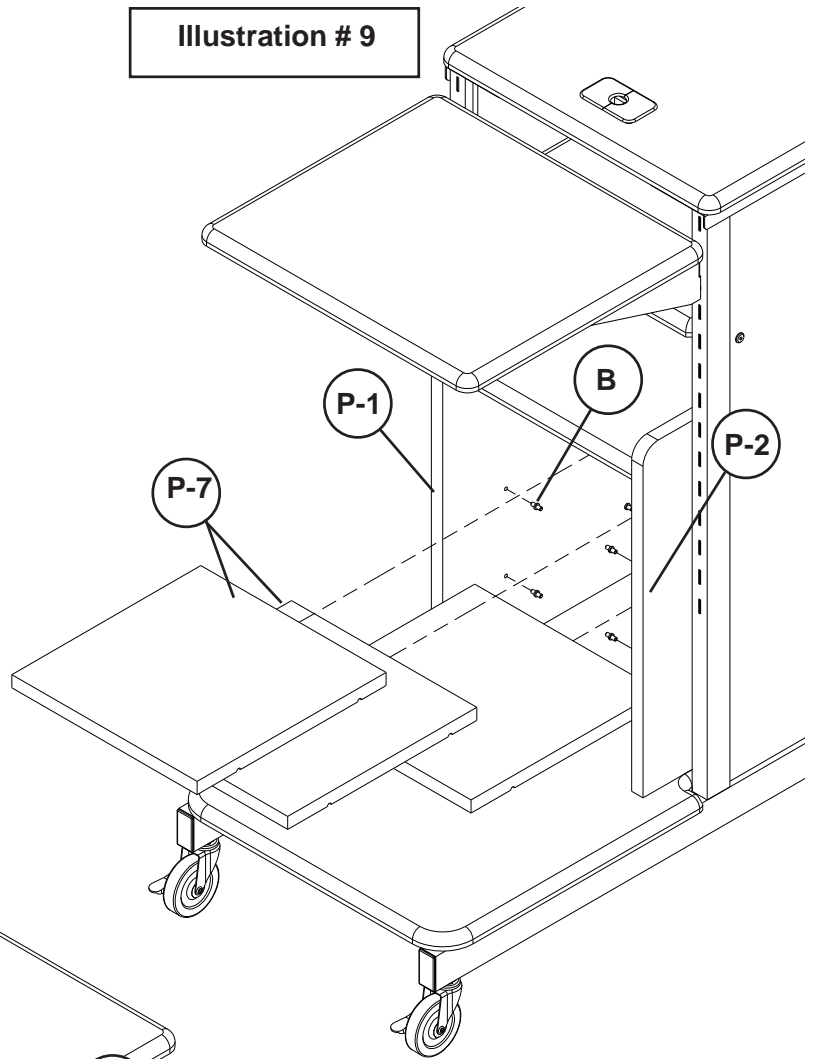

23. Insert the end of Spring Buttons (E) into the holes in Top Panel (P-4) and Bottom Platform (P-5) as shown in illustration # 10.

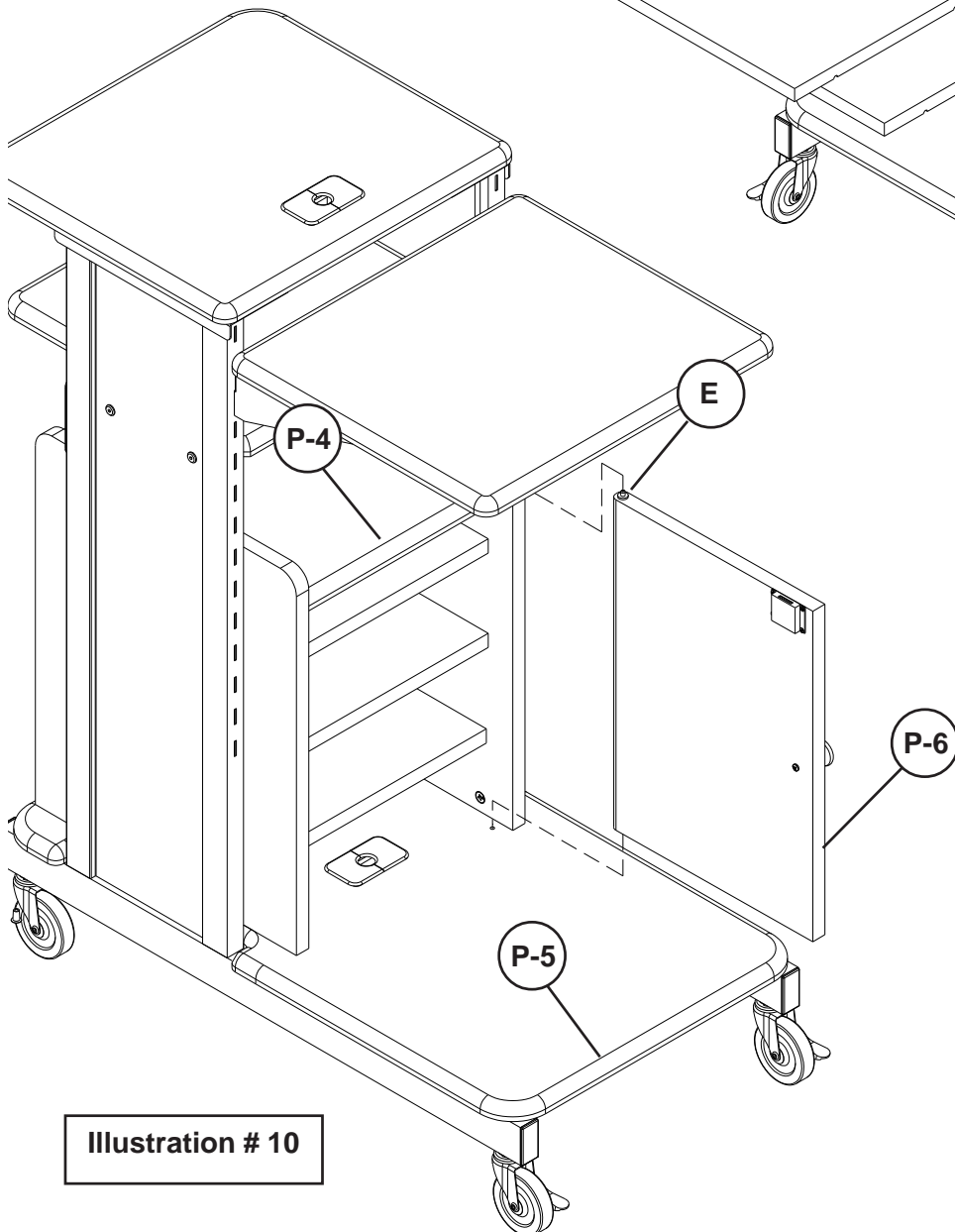
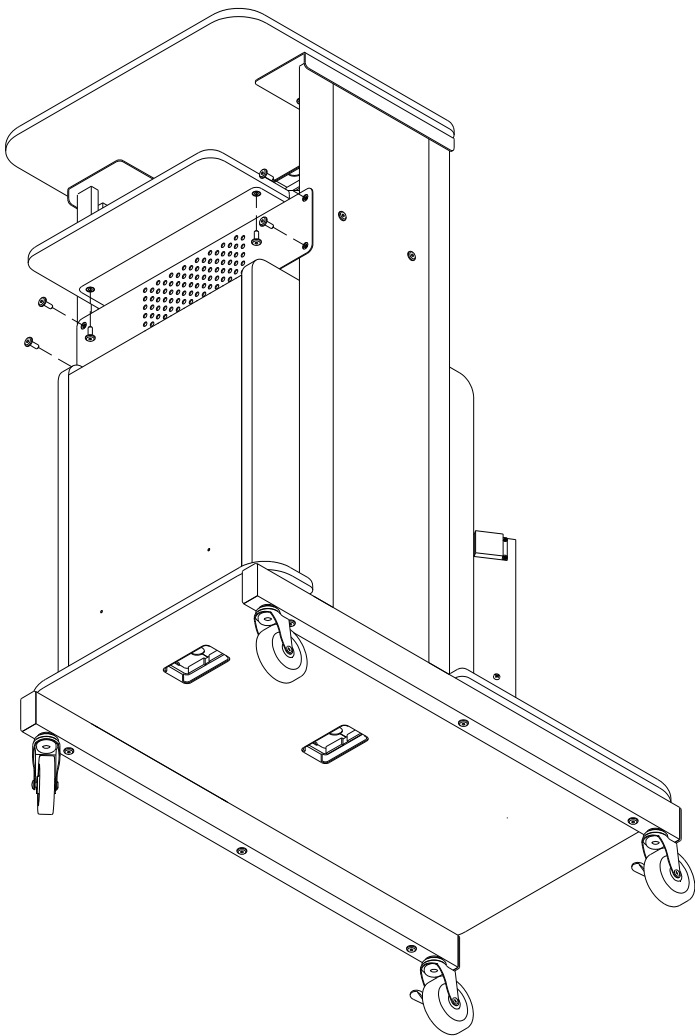

Illustration # 10

**Illustration # 11**



24. Replace Stability Panel using 6 Screws and Allen Wrench (L) as shown in illustration #11.

25. Insert Key (H) as shown in illustration # 12 and turn lock counter-clockwise to lock door.

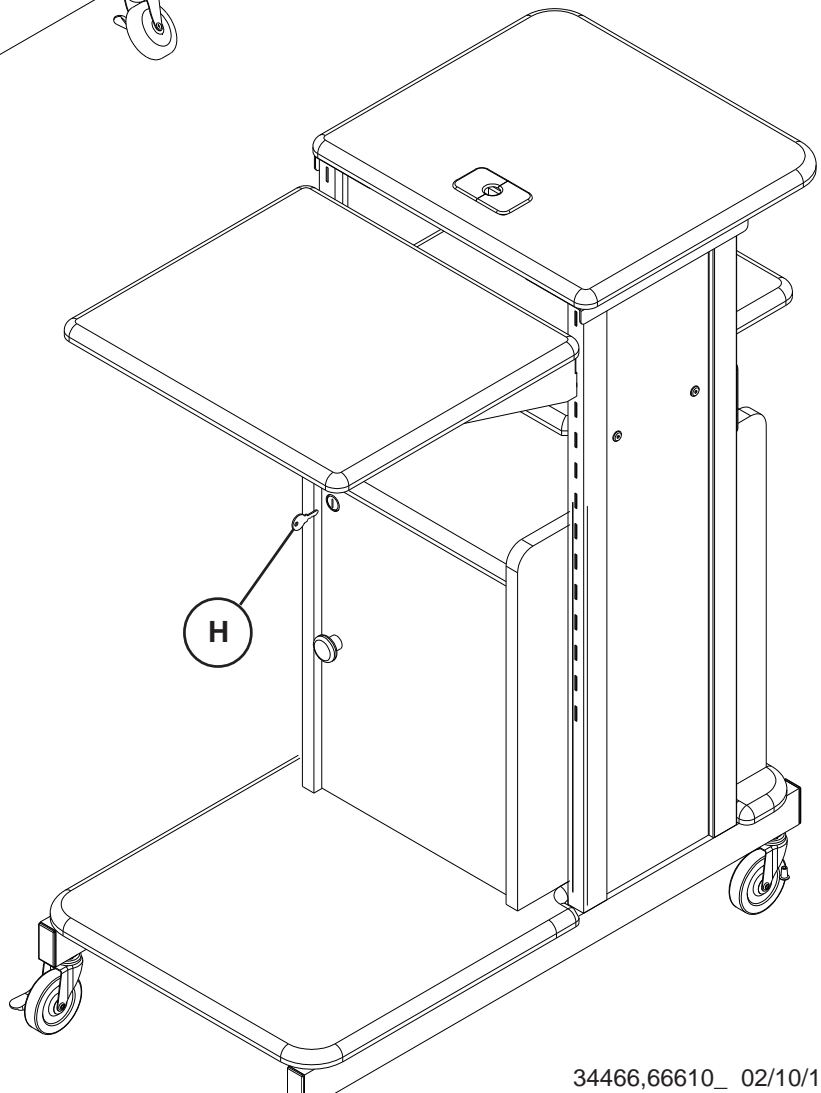

**Illustration # 12**